

VOLVO

Volvo Buses, 7900 Hybrid

Body type: Low floor 12m, 3-doors
Production start: 2012

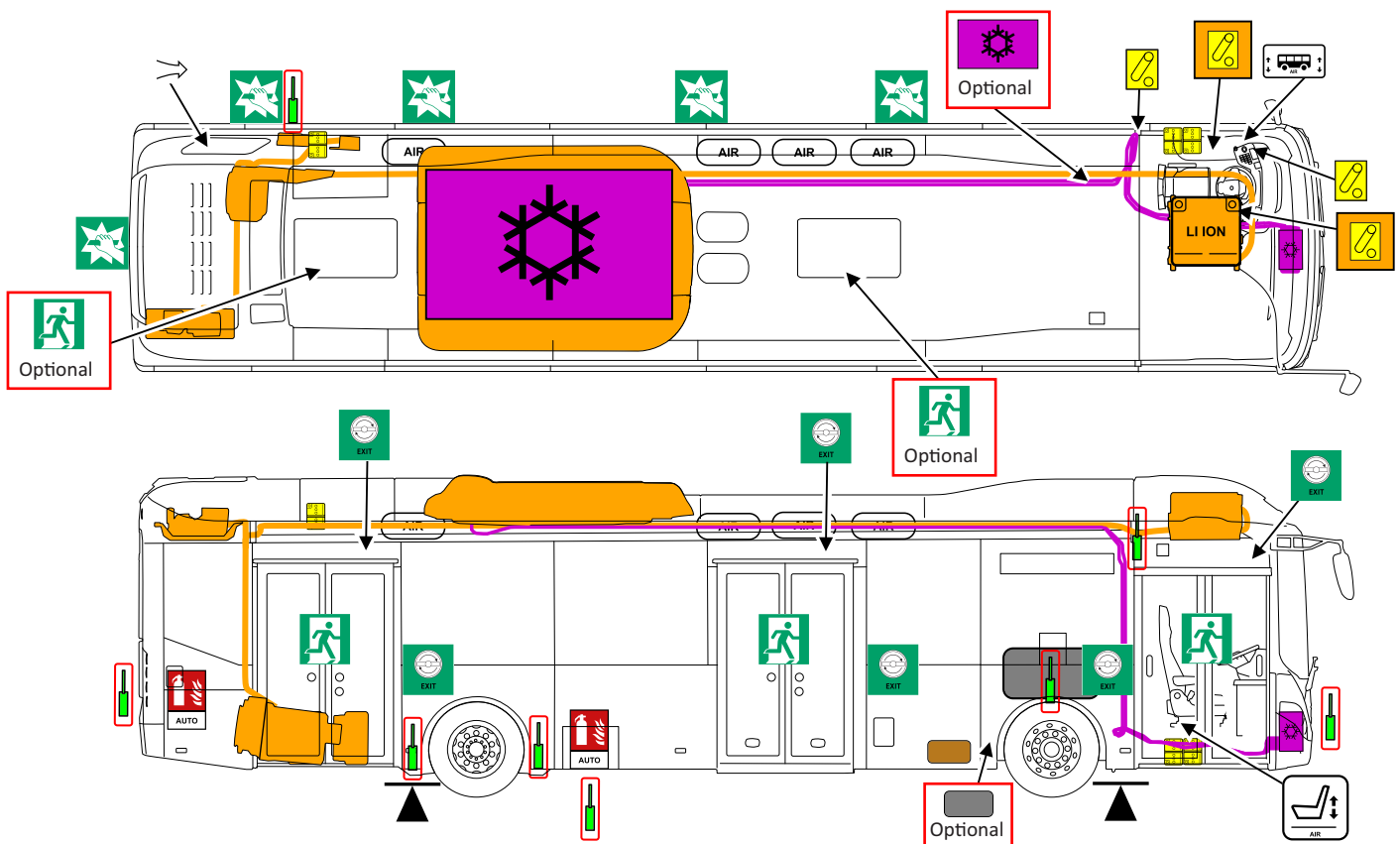
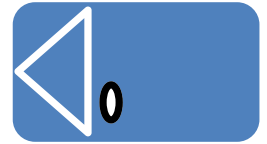

		Traction voltage battery (600 V), lithium-ion				
		Emergency door opener				
		Auto fire suppression				

1. Identification / recognition

Hybrid bus

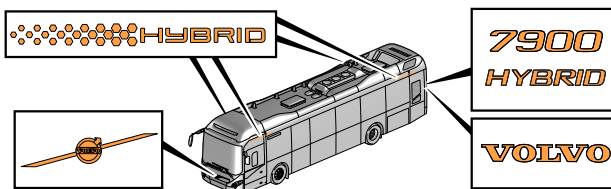

2. Immobilisation / stabilisation / lifting

I. Immobilise the vehicle

1. Chock the wheels.
2. Apply the parking brake.
3. Select the N (neutral) position.

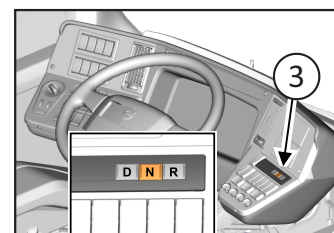
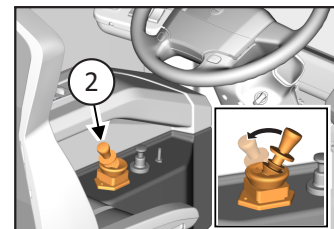
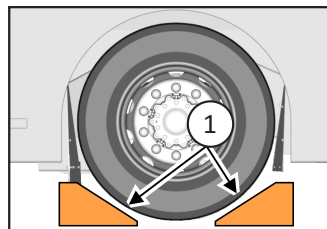

II. Lifting points



Use only these lifting points (see page 1).

3. Disable direct hazards / safety regulations



Always assume that the bus is powered, even if it is silent!

In case of 600 V battery failure, risk of voltage on the traction cables exists, even if the power is off!

Note! Do not touch or cut orange traction voltage power cables. Do not touch or open traction voltage components.

600 V components need 5 seconds to discharge their capacitance.

I. Disabling traction voltage

I.I Emergency method



Variant (A) of the emergency switch

1. Lift the flap.
2. Press the emergency switch.

Note! Do not close the flap after pressing the switch.

Closing the flap causes the switch to reset and reconnect 600 V system.

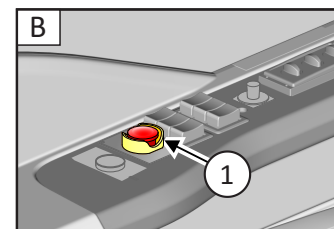
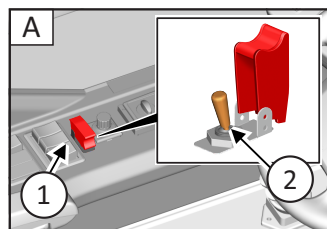

Variant (B) of the emergency switch

1. Press the emergency switch.

I.II Alternative method

Note! Make sure that the bus is not charging.

Note! The battery cables can be live even if the switch is in „0” position or the batteries are disconnected.



1. Turn off the ignition.



2. Turn off the power.

Note! Wait at least 30 seconds.



3. Turn the switch to position „0”.

4. Remove the battery cables (plus „+” and minus „-”).

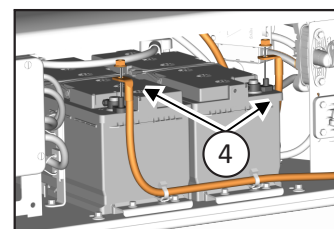
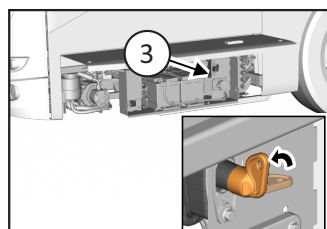
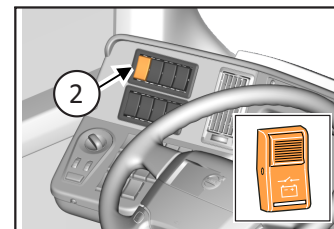
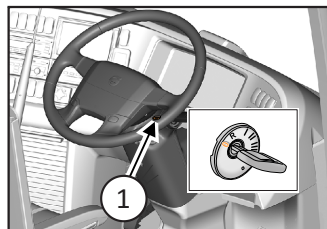

4. Access to the occupants



Break these windows to obtain access (tempered glass).



Three emergency door opening buttons inside and outside the vehicle.



Three exits through doors.
Two exits through roof (optional).

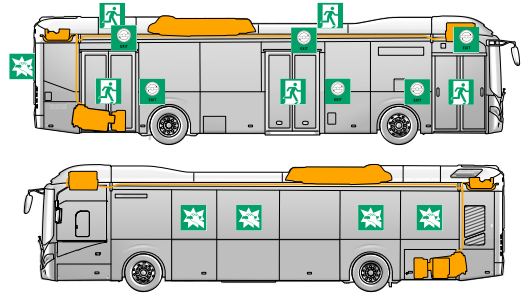

5. Stored energy / liquids / gases / solids

I. 600 V traction voltage lithium-ion battery



II. Other liquids/gases



6. In case of fire

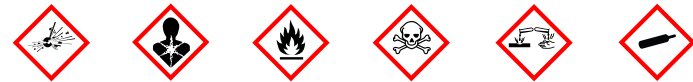

I. Lithium-ion battery related fire

Symptoms of the battery fire:

1. Fire alarm on a dashboard.
2. Smoke or streaks of intense fire rising from under the traction voltage battery cover.

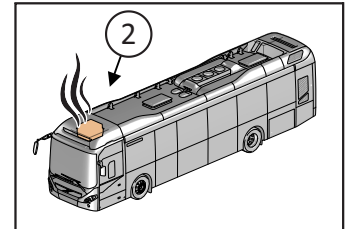
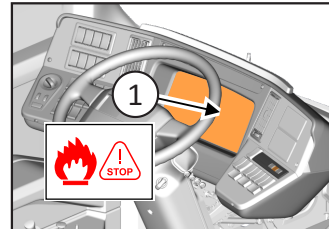

Use large amounts of water to put out the lithium-ion battery related fire.

Note! If electrolyte comes into contact with water, hydrofluoric acid and hydrogen gas may be formed.

Do not use a class ABC fire extinguisher for the battery related fire! ABC Dry chemical is ineffective.

When fighting the fire with water, any electrical hazards have to be considered and rules have to be respected.

Hydrogen fluoride, carbon monoxide, carbon dioxide can be released. Wear Self Contained Breathing Apparatus (SCBA) and cover your skin.

Risk of battery re-ignition (see chapter 8).

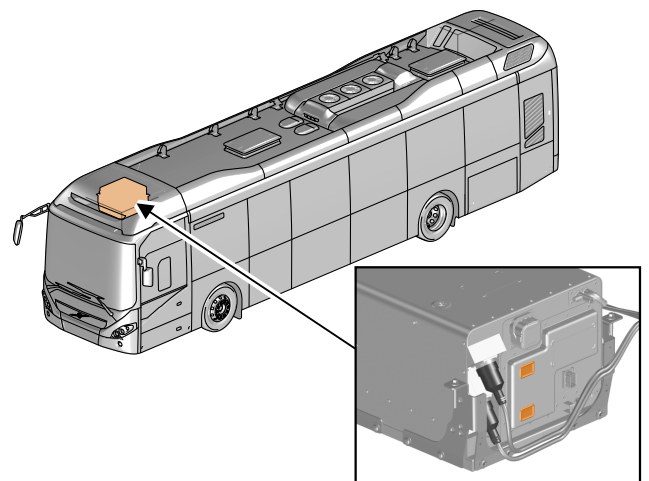

II. Fire related to other material



Can only occur in the following compartments:

- auxiliary heater
- engine compartment



If other materials are involved, a class ABC fire extinguisher can be used.

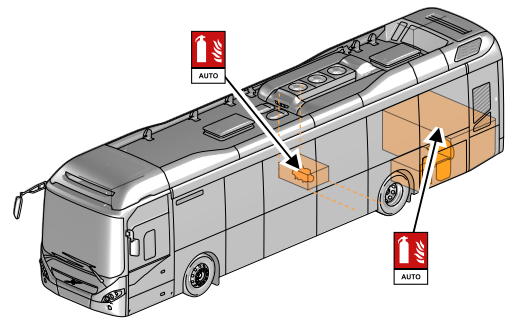

7. In case of submersion



If possible:

1. Remove the vehicle from the water.
2. Disable direct hazards (see chapter 3).

Note! Risk of traction voltage battery fire after submerged in salt water.



Risk of serious injury or death from electric shock. Wear appropriate Personal Protective Equipment (PPE).

If electrolyte comes into contact with water, hydrofluoric acid and hydrogen gas may be formed.

8. Towing / transportation / storage

I. Storage post fire/crash



Store the bus in a safe distance from other vehicles, buildings and combustible objects.



Risk of battery fire re-ignition after incident.

Observe the batteries for at least 48 hours. Toxic and flammable gases can be released.



In case of open cells, there is a risk for release of hydrofluoric acid and carbon monoxide.

If severe damage causes exposing of traction voltage components, use PPE including SCBA.

II. Towing

Towing device (A) is located on the front of the bus.

Towing eyes (B) are located on the front and the rear of the bus.

Note! Secure the pin before towing (C).

Allowed methods:

1. Towing.
Note! Use only front towing eye for towing the bus with all wheels on the ground.
2. Lifting and towing.
3. Transporting.

Note! Remove the propeller shaft from the drive axle before towing.

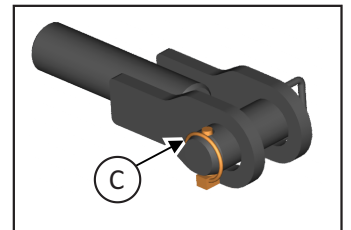
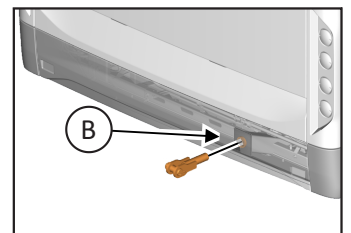
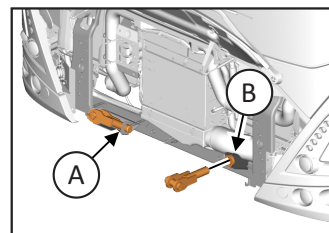

9. Important additional information



Do not touch or cut orange traction voltage power cables.

Do not touch or open traction voltage components.

Do not damage the battery pack, even if the propulsion system is deactivated.

Do not step on or press on damaged batteries.

Always use PPE when working on hybrid vehicle.